

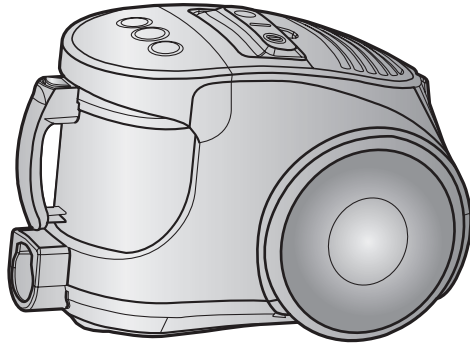

Operating Instructions



VACUUM CLEANER



- * Before operating this unit, please read the instructions carefully.
- * Indoor use only.

Register your product at www.samsung.com/global/register

IMPORTANT SAFEGUARDS

1. Read all instructions carefully. Before switching on, make sure that the voltage of your electricity supply is the same as that indicated on the rating plate on the bottom of the cleaner.
2. **WARNING:** Do not use the vacuum cleaner when rug or floor is wet.
Do not use to suck up water.
3. Close supervision is necessary when any appliance is used by or near children. Do not allow the vacuum cleaner to be used as a toy. Do not allow the vacuum cleaner to run unattended at any time. Use the vacuum cleaner only for its intended use as described in these instructions.
4. Do not use the vacuum cleaner without a dust bin. Empty the dust bin before it is full in order to maintain the best efficiency.
5. Do not use the vacuum cleaner to pick up matches, live ashes or cigarette butts. Keep the vacuum cleaner away from stoves and other heat sources. Heat can deform and discolour the plastic parts of the unit.
6. Avoid picking up hard, sharp objects with the vacuum cleaner as they may damage the cleaner parts. Do not stand on the hose assembly. Do not put weight on the hose. Do not block the suction or the exhaust port.
7. Switch the vacuum cleaner off on the body of the machine before unplugging from the electrical outlet. Disconnect the plug from the electrical outlet before changing the dust bag or dust container. To avoid damage, please remove the plug by grasping the plug itself, not by pulling on the cord.
8. This appliance is not intended for use by young persons or infirm persons without supervision unless they are adequately supervised by a responsible person to ensure that they can use the appliance safely.
Young children should be supervised to ensure that they do not play with the appliance.
9. The plug must be removed from the socket outlet before cleaning or maintaining the appliance.
10. The use of an extension cord is not recommended.
11. If your vacuum cleaner is not operating correctly, switch off the power supply and consult an authorized service agent.
12. If the supply cord is damaged, it must be replaced by the manufacturer or its service agent or a similarly qualified person in order to avoid a hazard.
13. Don't carry the vacuum cleaner by holding the hose.
Use the handle on the vacuum cleaner set.

1 ASSEMBLING THE CLEANER

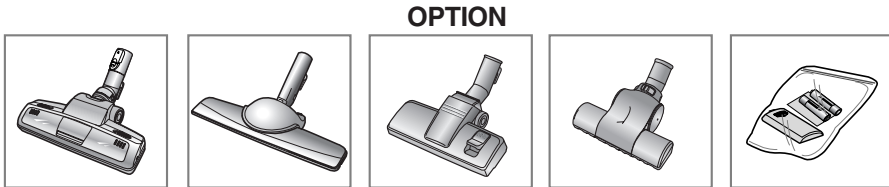
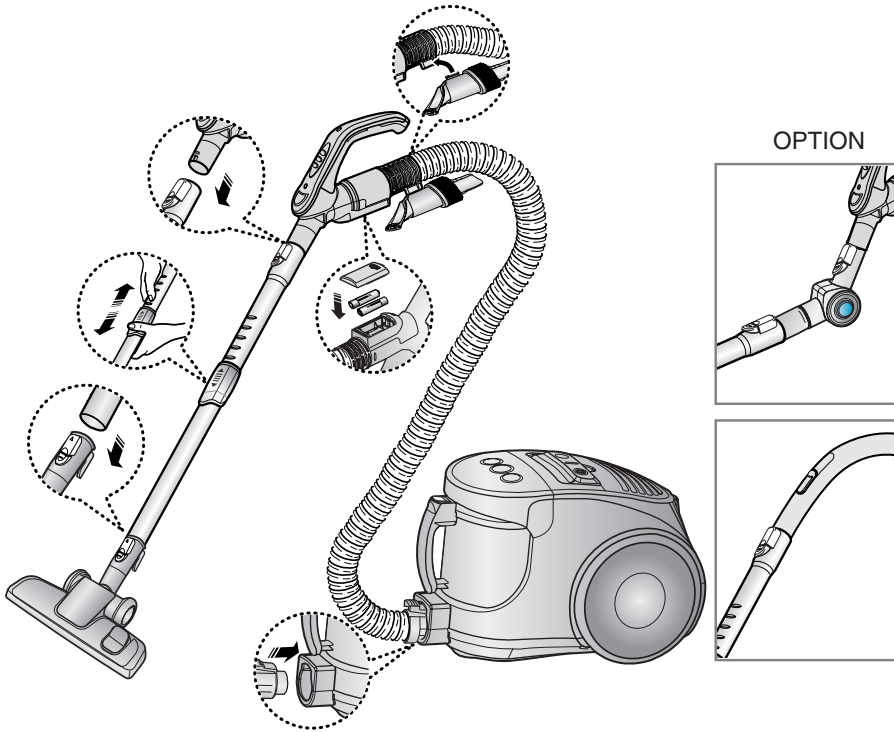

► Features may vary according to model.

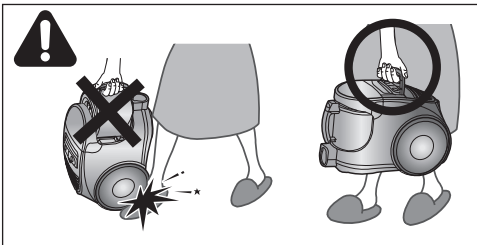

CAUTION : Please do not use dust bin handle when carrying machine.

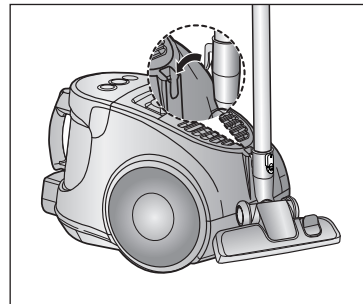

For storage, park the floor nozzle.

2 OPERATING THE CLEANER

2-1 ON/OFF SWITCH

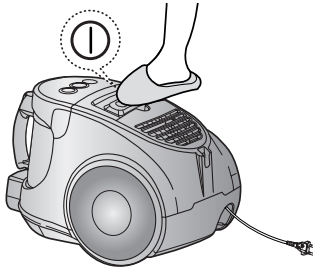

2-2 POWER CORD

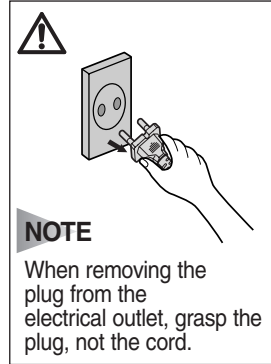
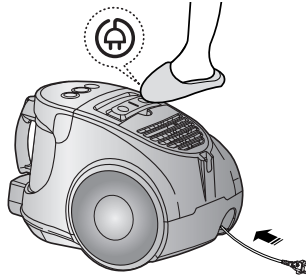

2-3 POWER CONTROL (INFRARED CONTROL)

1) REMOTE CONTROL TYPE

- HOSE

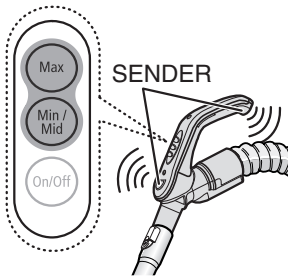

HANDLE CONTROL

[The cleaner is controlled by using infrared signals.]

1. Vacuum cleaner ON/OFF
Press the ON/OFF button to operate the vacuum cleaner.
Press again to stop the vacuum cleaner.
2. Vacuum cleaner MIN/MID
Press the MIN/MID button to operate the vacuum at a low level (for curtain cleaning, etc.).
Press again to operate the vacuum in a MID mode.
3. Using at MAX
Press the MAX button to operate the vacuum at maximum intake.

- BODY

OPTIONAL - DIGITAL SIGNAL

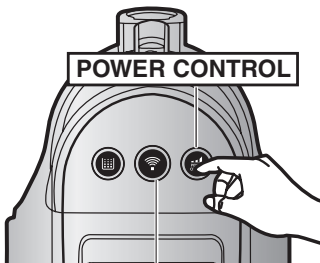

RECEIVER

Press the power control button repeatedly to select the correct mode.
(ON(MIN) → MID → MAX → OFF)

NOTE : If the remote handle control is not working, the cleaner can be operated using the control button on the body of the machine.

2) BODY-CONTROL TYPE

- HOSE

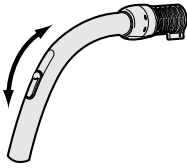

To reduce suction for cleaning draperies, small rugs, and other light fabrics, pull the tap air until the hole is open.

- BODY

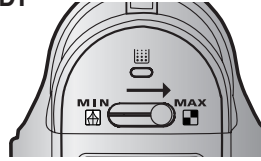





MIN = For delicate surface e.g. net curtains.

MAX = For hard floors and heavily soiled carpets.

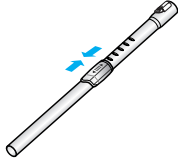

2-4 HOW TO USE AND MAINTAIN THE ACCESSORIES

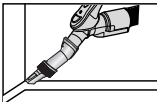
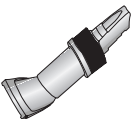
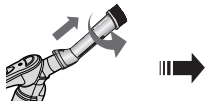
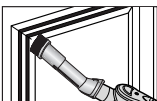
► Features may vary according to model.

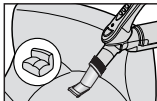

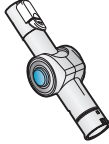
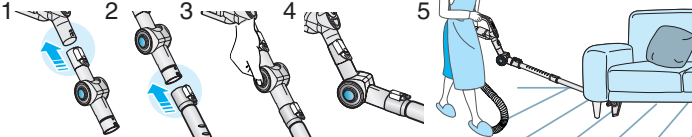
| PIPE |   <p>Adjust the length of the telescopic pipe by sliding the length control button located in the center of the telescopic pipe back and forth.</p> |  <p>To check for blockages, separate the telescopic pipe and adjust to shorten. This allows for easier removal of waste clogging the tube.</p> |
|------|---|---|
|------|---|---|

| ACCESSORY |   <p>Push the accessory on to the end of the hose handle.</p> |
|--|---|
|  |   <p>Pull out and turn the dusting brush for cleaning delicate areas.</p> |
| |   <p>To use the upholstery tool, push the accessory on to the end of the hose handle in the opposite direction.</p> |

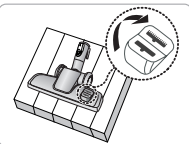
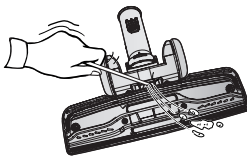
| ELBOW EXTENDING TUBE (OPTION) |   <ol style="list-style-type: none"> 1. Connect the elbow extending tube to connecting part for hose knob and telescopic pipe. 2. Fit the telescopic pipe to the lower part of the elbow extending tube. 3. Press the PUSH button. 4. With the PUSH button pressed, the elbow extending tube is folded. 5. Using the elbow extending tube allows hard to reach areas (e.g. under furniture) to be cleaned without having to kneel down. |
|-------------------------------|---|
|-------------------------------|---|

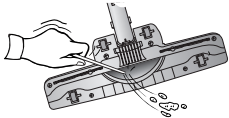
| | | |
|--|--|--|
| <p>OPTION</p>  | <p>▶ Carpet Cleaning</p>  <p>▶ Floor Cleaning</p>  <p>Adjust the inlet lever according to the floor surface.</p> |  <p>Remove waste matter completely if the inlet is blocked.</p> |
|--|--|--|

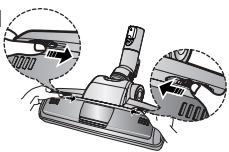
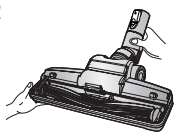
| | | |
|--|---|--|
| <p>OPTION</p>  | <p>Vacuum dust in wide area at once</p> |  <p>Remove waste matter completely if the inlet is blocked.</p> |
|--|---|--|

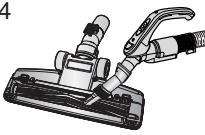
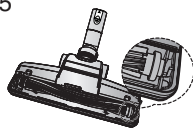
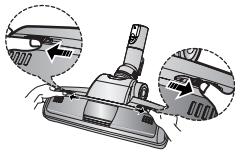
| | |
|---|---|
| <p>OPTION</p>  <p>For improved pick-up of pet hair and fibre on carpets</p> | <p>Frequent vacuuming of hair or pet fur may cause a falling-off of the rotation due to matters tangled around the drum. In this case, clean the drum with care.</p> <ol style="list-style-type: none">  <p>1 Push the Open button of the transparent screen cover to separate the cover.</p>  <p>2 Remove the brushbar from the transparent screen.</p>  <p>3 Remove waste matter such as dust and hair tangled around the brushbar using scissors.</p>  <p>4 Remove dust inside the brush housing using a dry duster or crevice tool.</p>  <p>5 Insert brushbar into rotating belt and assemble.</p>  <p>6 Click the transparent screen cover back into place to reassemble.</p> |
|---|---|

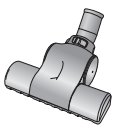
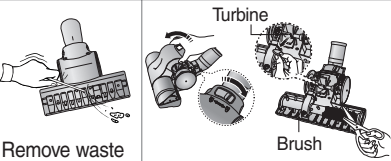
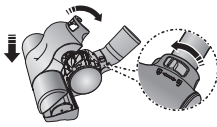
| | |
|---|---|
| <p>OPTION</p>  <p>Brush for blanket</p> <p>For picking up pet hair and fibre on upholstery and bed linen.</p> | <p>Clogs on turbine keeps brush from turning, and in this case, take care of it.</p>  <p>Remove waste matter completely when inlet is blocked.</p> <p>Turn the lock button to 'UNLOCK', and remove waste matter.</p>  <p>To reassemble, align the cover to the front of the main body and close. After closing the cover, ensure that the lock button is turned to the 'LOCK' position.</p> <p>Warning : Use for bedclothes only. Be cautious not to damage brush during unclogging.</p> |
|---|---|

3 EMPTYING THE DUST BIN

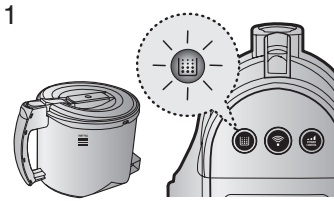

Once dust reaches the dust full mark, or once the dust full light is on, empty the dust bin.

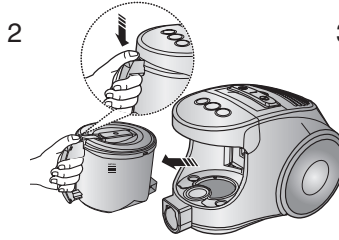

Take the dust bin out by pressing the button.

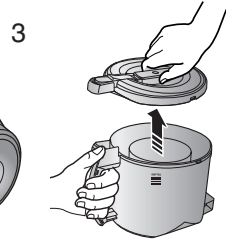

Separate the dust bin cover.

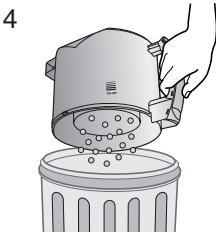

Throw away dust in the bin.

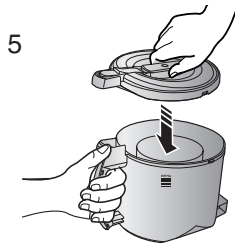

Close the dust bin cover.

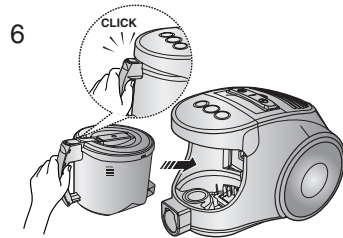

Before use, push the dust bin into the main body of the vacuum cleaner until you hear the "click" sound.

- Empty into a plastic bag (recommended for asthma/allergy sufferers)

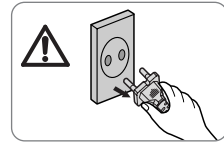
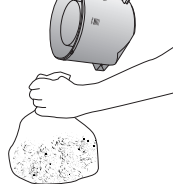
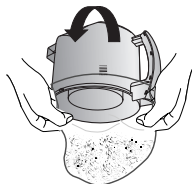

NOTE

You may rinse the dust bin with cold water



4 CLEANING THE DUST PACK

4-1. WHEN TO CLEAN THE DUST PACK

- If suction is noticeably reduced during cleaning, please check the dust pack as indicated below.

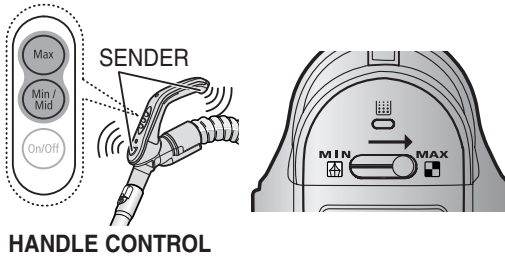

Turn the vacuum power to 'MAX'

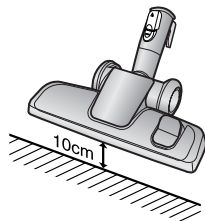

If the filter check indicator turns red with the inlet floating 10 cm above flat floor, clean it.

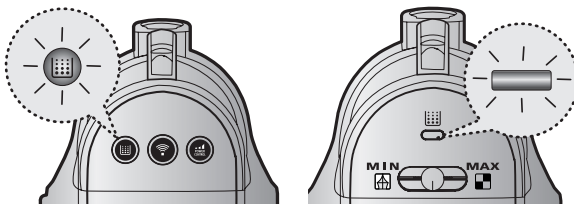

When the indicator light comes on, please empty the Dust Pack(4-2) as shown in the following illustrations.

4-2 CLEANING THE DUST PACK

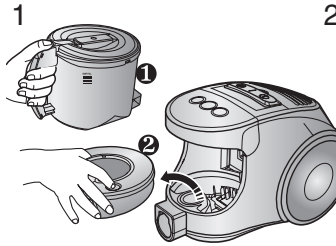

Remove the dust bin and dust pack as shown.

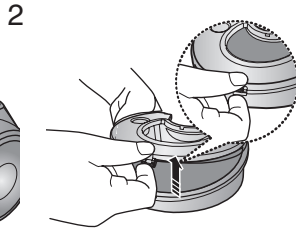

Remove the fixed frame of the dust pack cover.

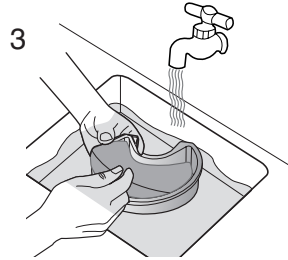

Remove the sponge pad from the dust pack

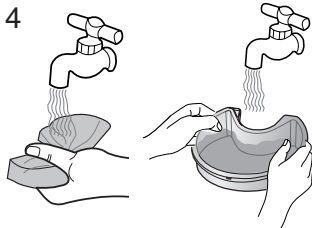

Wash the sponge and the filter of the dust pack with water.

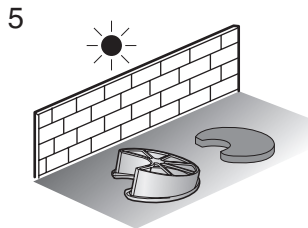

Let the sponge and dust pack dry in the shade for more than 12 hours.

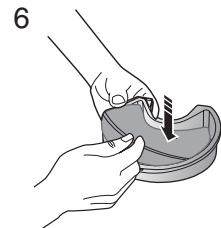

Put the sponge into the dust pack.

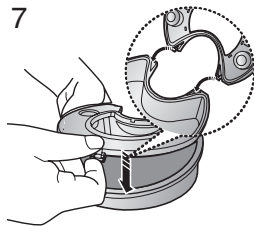

Before reassembly, align the dust pack cover and dust pack correctly.

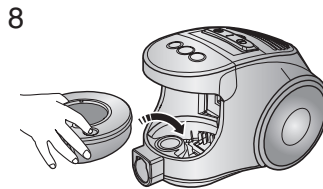

Put the assembled dust pack into the main body.



NOTE : Make sure the filter is completely dry before putting it back into the vacuum cleaner. Allow 12 hours for it to dry.

5 CLEANING THE MOTOR PROTECTION FILTER

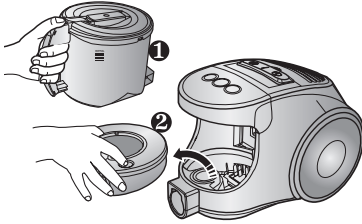

Take out both the dust bin and the dust pack.

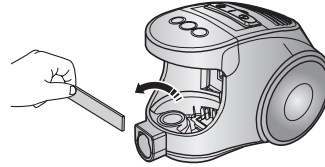

Remove the motor protection filter from the vacuum cleaner. Shake and tap the dust from it and put back in machine.

6 CLEANING THE OUTLET FILTER

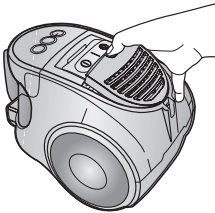

Press the fixed frame part at the back of the main body to remove.

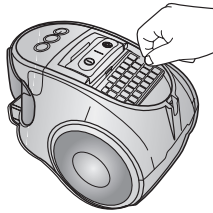

Pull out the HEPA Filter using the tab.

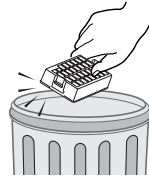

Dust the HEPA filter.

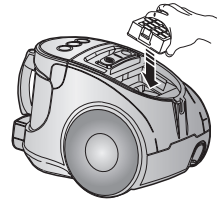

Put the HEPA filter into the main body until you hear a 'click' sound.

OPTION - MICRO CARBON FILTER

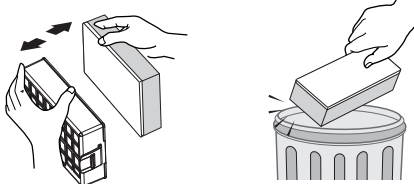

Remove and replace the blocked outlet filter.

NOTE : Replacement filters are available at your local Samsung distributor.

7 CHANGE THE BATTERY(OPTIONAL)

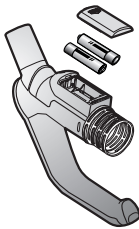

BATTERY TYPE : AA Size



NOTE

1. When the vacuum cleaner does not work, replace the batteries.
If the problem persists, please contact our authorized dealer.
2. Use 2 batteries of size AA.



WARNING

1. Never disassemble or recharge the batteries.
2. Never heat up the batteries or throw them into fire.
3. Do not reverse (+),(-) poles.
4. Dispose of the batteries properly.

- IF YOU HAVE A PROBLEM

| PROBLEM | CAUSE | REMEDY |
|--|---|--|
| Motor does not start. | No power supply. Thermal cut-out. | Check cable, plug and socket. Leave to cool. |
| Suction force is gradually decreasing. | Nozzle, suction hose or tube is blocked. | Check for blockage and remove it. |
| Cord does not rewind fully. | Check that the cord is not twisted or wound unevenly. | Pull the cord out 2-3m and push the cord rewind button. |
| Vacuum cleaner does not pick up dirt. | Crack or hole in hose. | Check hose and replace if required. |
| Low or decreasing suction | Filter is full of dust. | Please check filter and, if necessary, clean as illustrated in the instructions. |

If you have any comments or questions regarding a Samsung products, contact the SAMSUNG customer care center.

| Country | Customer Care Center ☎ | Web Site |
|-----------|------------------------|--|
| AUSTRALIA | 1300 362 603 | www.samsung.com/au |
| HONG KONG | 2862 6001 | www.samsung.com/hk |
| MALAYSIA | 1800-88-9999 | www.samsung.com/my |
| SINGAPORE | 1800-SAMSUNG (7267864) | www.samsung.com/sg |

